

Luralite™

Decorative Glueboard Insect Control

Please read these instructions carefully and store in a safe place for future reference.

LURALITE™

As part of the **Insect-O-Cutor®** brand of insect control products, **Luralite™** is an easy to service and highly effective decorative insect control unit for use within front of house applications. **Luralite™** utilises highly effective UV tubes and is designed for use with a high specification glupac® glueboard. Two sizes of unit are available - The compact **Luralite Cento™** and the highly effective **Luralite Professional™**.

Contents of package

- 1 x Luralite flykiller chassis
- 1 x Luralite flykiller guard
- 1 x Mains cable (Type X)
- 1 x glupac® pheromone impregnated glueboard
- 2 x Screws and wall plugs
- 1 x Compact 18W tube (fitted)
- or
- 2 x 15W High powered insect attractive UV tubes (fitted)

WARNING - THIS APPLIANCE MUST BE EARTHED (CLASS 1)

INSECT CONTROL PRODUCTS

Luralite™ utilises high powered ultra violet tubes to attract flying insects and retains the caught insects on a pheromone impregnated glueboard for inspection or hygienic disposal.

WARNING

Luralite™ is not to be used by children or persons with reduced physical, sensory or mental capabilities, or lack of experience and knowledge, unless they have been given supervision or instruction.

Children should be supervised to ensure they do not play with the appliance.

If the mains cable is damaged it must be replaced by a specialist mains cable available from Pelsis Ltd or your supplier.

Not suitable for applications where potentially explosive environments may exist.

POSITIONING AND GUIDANCE FOR USE

THIS UNIT IS FOR INDOOR USE ONLY. NOT SUITABLE FOR USE IN BARN, STABLES & SIMILAR LOCATIONS.

Luralite™ should ideally be fixed around two meters above the ground, preferably in the darkest place within the area to be protected. Do not position the unit close to windows, skylights or other sources of light, or where it may be obscured by furniture, doors or other obstacles. Ideally, **Luralite™** should be visible from every part of the area to be protected.

Luralite™ should ideally be in operation for 24 hours a day, ensuring your premises are kept free of flying insects. Insects are most attracted to **Luralite™** at night when there is no competition from daylight or other light sources.

GUARANTEE

Luralite™ has a two year guarantee and if maintained as recommended in these instructions should continue to work for many years.* Use of non-approved consumables may invalidate the guarantee. Ensure genuine glupac® glueboards are used in conjunction with this product.

INSTALLATION

INSTALLATION SHOULD BE CARRIED OUT BY SERVICE PERSONNEL ONLY.

Install **Luralite™** by fixing the chassis to the wall using the supplied wall plugs. (For specialist wall surfaces such as plasterboard, appropriate wall plugs should be used.) Keep out of the reach of children. Then offer the front guard into position, hooking into place on the two hooks at the top of the chassis.

Once **Luralite™** is installed in position, fit the glupac® glueboard in place as described in the glueboard replacement section of this document. Use the removable mains lead and plug to connect the **Luralite™** to an appropriate power supply.

CLEANING

CLEANING SHOULD BE CARRIED OUT BY SERVICE PERSONNEL ONLY, AFTER ENSURING THAT THE UNIT IS DISCONNECTED FROM THE MAINS SUPPLY.

It is recommended that cleaning is carried out regularly when the glueboard is replaced. Once the glueboard is removed, the unit should be thoroughly wiped down with a damp cloth, removing any build up of dirt. Ensure the unit is completely dry before reconnecting it to the power supply.

MOUNTING FIXING CENTRES

METHOD	Cento	Professional
Wall	190mm	380mm
Desk	-	-
Suspended	-	-

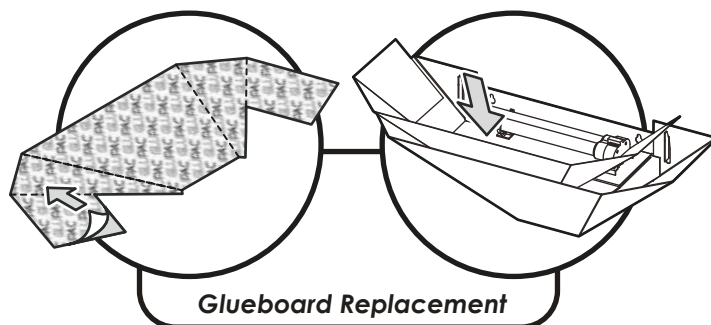
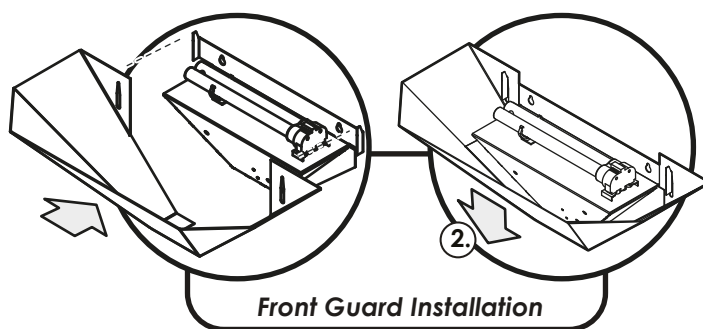

*Excludes tubes, glueboards and starters. Does not cover breakdown due to misuse, incorrect operation or use in an incorrect application.

Luralite™

GLUEBOARD REPLACEMENT

BEFORE REPLACING THE GLUEBOARD, ALWAYS ENSURE THAT THE UNIT IS DISCONNECTED FROM THE MAINS SUPPLY.

The glueboard should be replaced every month with a genuine glupac® glueboard. Use of non-approved glueboards may invalidate your guarantee. **Luralite™** comes supplied with a highly attractive yellow glueboards with printed grids for simple insect evaluation and monitoring.

To replace the glueboard...

1. Remove the used glupac® glueboard by simply sliding it out from the top of the unit and either retain for catch evaluation or dispose of it hygienically.
2. Remove the protective release paper from the new glupac® glueboard.
3. Slowly slide the new glupac® glueboard into position with the adhesive side facing the tube(s).

Always ensure the selected genuine glupac™ glueboards are compatible with your unit, available from your pest control operator or Pelsis Ltd.

TUBE REPLACEMENT

TUBE REPLACEMENT SHOULD BE CARRIED OUT BY SERVICE PERSONNEL ONLY, AFTER ENSURING THAT THE UNIT IS DISCONNECTED FROM THE MAINS SUPPLY.

To ensure the efficiency of **Luralite™** in catching flying insects, the UV tube(s) should be replaced annually. After twelve months the phosphor coating that emits the correct wavelength of UV light has burnt away and the UV output is diminished substantially.

To replace the UV tube(s)...

Luralite Cento

1. Pull the tube gently from the tube holder until it un-clips.
2. Gently rotate the tube until it becomes free from the tube support.
3. Reverse the process with the replacement tube.
4. Dispose of the used UV tube in conjunction with local WEEE regulations.

Luralite Professional

1. Rotate the tube through 90 degrees.
2. Gently pull the tube away from the unit.
3. Reverse the process with the replacement tube.
4. Dispose of the used UV tube in conjunction with local WEEE regulations.

STARTER REPLACEMENT

STARTER REPLACEMENT SHOULD BE CARRIED OUT BY SERVICE PERSONNEL ONLY, AFTER ENSURING THAT THE UNIT IS DISCONNECTED FROM THE MAINS SUPPLY.

The starter(s) provide(s) an extra spark to initially light the UV tube(s). Starter(s) wear out and should be replaced at the same intervals as the UV tube(s).

To replace the starter(s)...

1. Remove the glueboard from the units described above.
2. Rotate the starter anti-clockwise.
3. Pull the starter free from the unit.

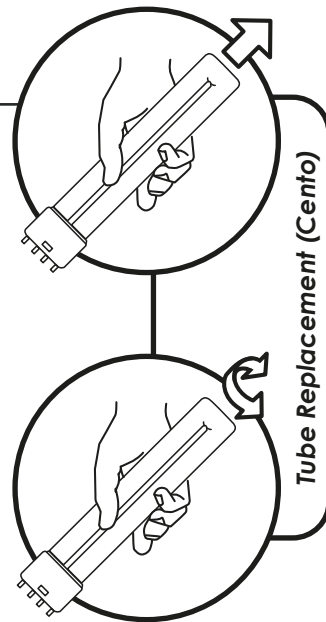

Tube Replacement (Cento)

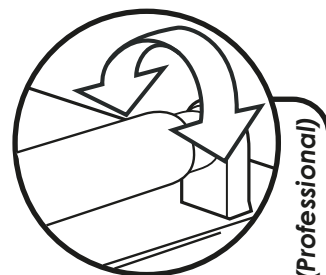
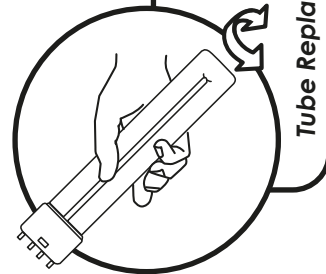

Tube Replacement (Professional)

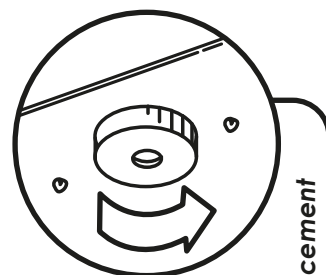
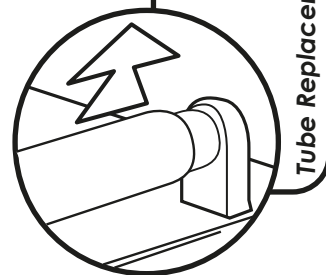

Starter Replacement

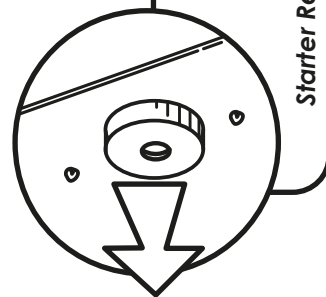

SPECIFICATION / REPLACEMENT PARTS

Unit	Luralite Cento	Unit	Luralite Professional
Voltage	230V ~ 50Hz	Voltage	230V ~ 50Hz
Dimensions(mm)	465 x 170 x 200	Dimensions(mm)	730 x 210 x 200
Coverage	25 Sq. Metres	Coverage	50 Sq. Metres
Weight	1.5 Kg	Weight	2.5 Kg
Light Output	18W	Light Output	30W
Tube	1 x TPX18	Tubes	2 x TPX15-18
Starter	1 x I154	Starters	2 x I154
Glueboards (x6)	INL118 (Yellow)	Glueboards (x6)	INL121 (Yellow)